

Typ 33 666 04

Octavia III. RS Limousine 2013 →
Octavia III. RS Combi 2013 →



ca ... 2 h

Milotec®

Diffusor • Difuzor • Diffuser • Diffuseur d'air

Montageanleitung • Montážní návod
Fitting instructions • Instructions de montage

Technische Änderungen vorbehalten
Technická změna vyhrazena
Subject to technical alterations
Sous réserves de modifications techniques

Lieferumfang • Obsah balení • The pack contains • Fournitures:

Ⓐ 1 x

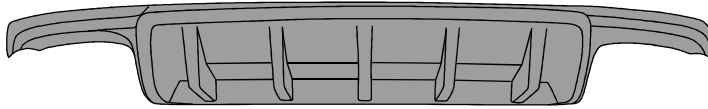

Ⓑ 1 x



Ⓒ 1 x



Ⓓ 1 x

Montageanleitung
Montážní návod
Fitting instructions
Instructions de montage

Werkzeug • Nářadí • Tools • Outils

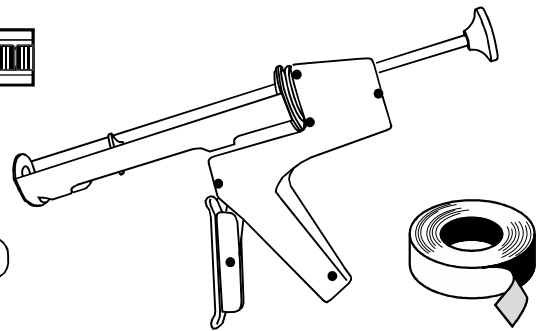
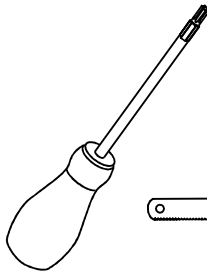
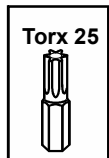

1.

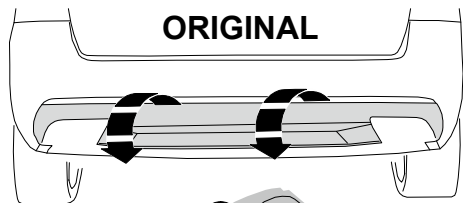

ORIGINAL

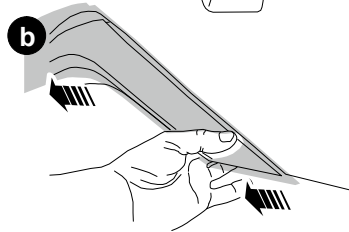

TORX 25

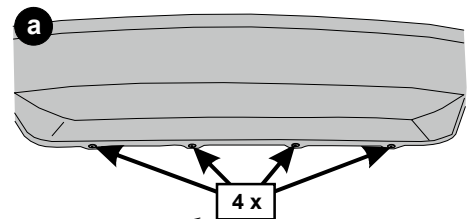

4 x

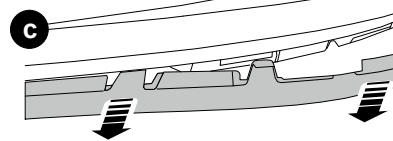

2.

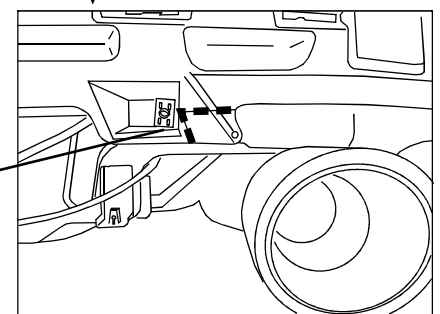
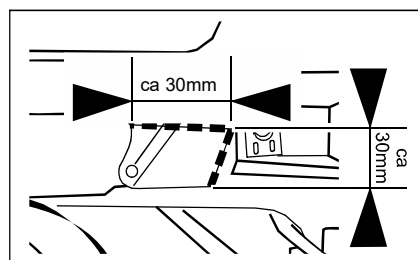
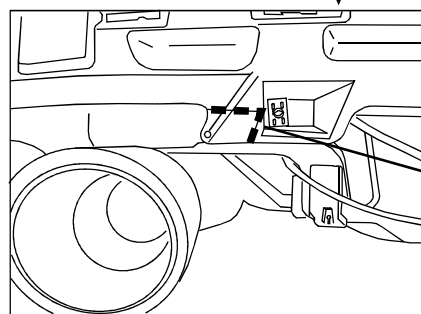
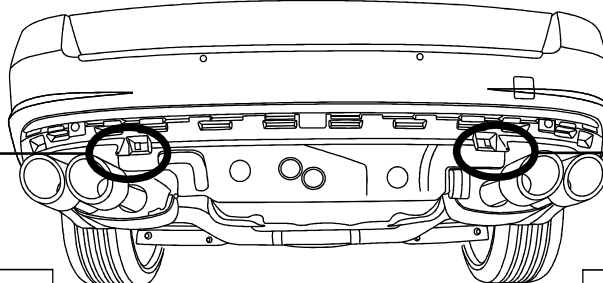
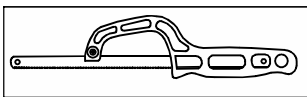

3.



TEST

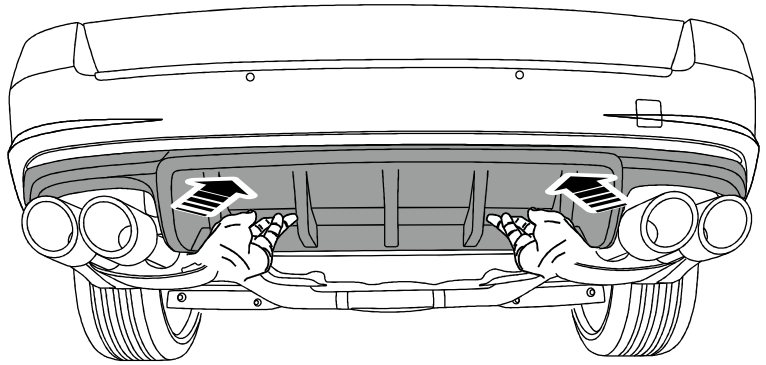
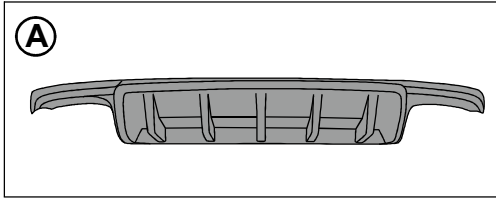

4.

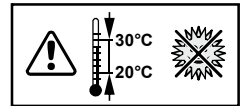
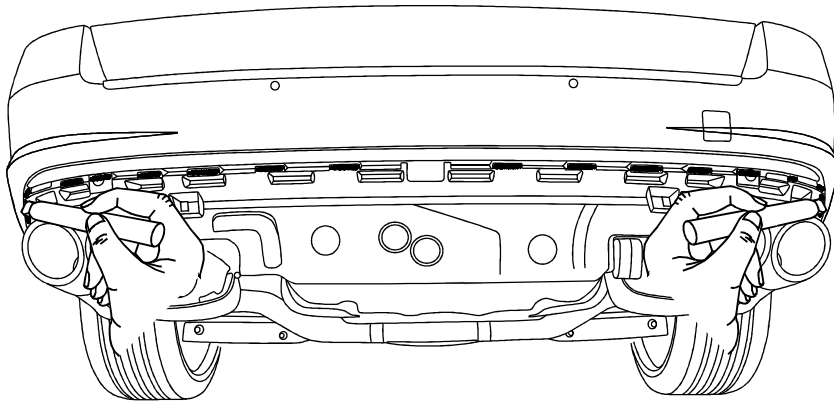

SIKA PRIMER-206

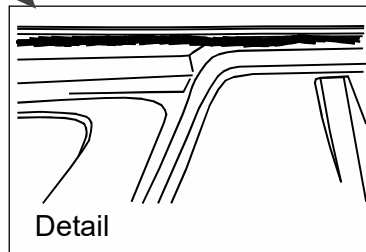
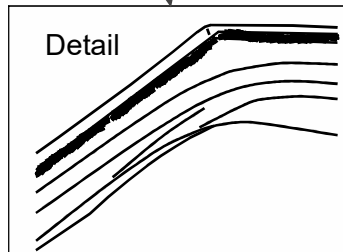
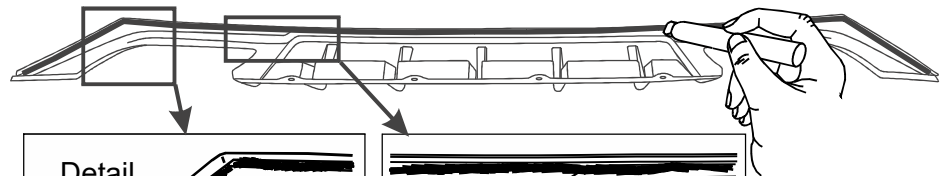

...20 min.

5.

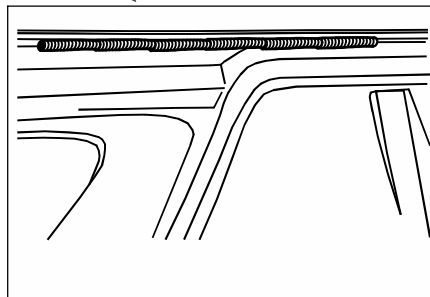
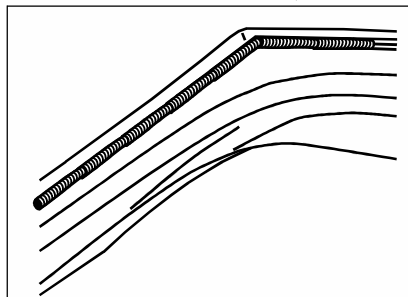
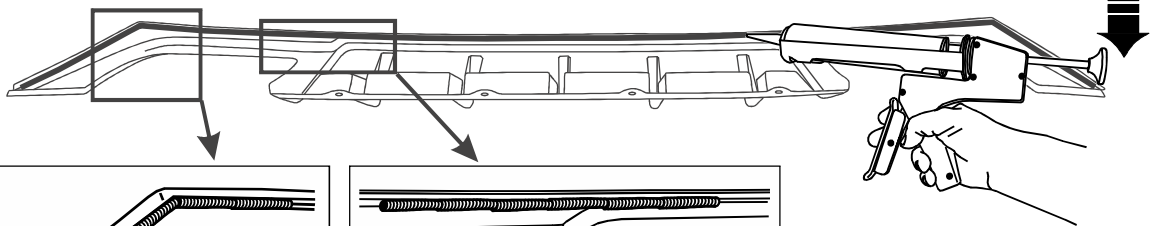

Polyurethan

